











HAMILTON POKER TABLE

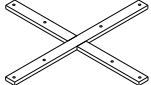

Presidential Billiards, L.P.

COMPONENT PARTS				
PACKAGE	ITEM #	SAMPLE	DESCRIPTION	QTY.
HARDWARE	H1		PRE-INSTALLED ON BOLTS	4
	H2		PRE-INSTALLED ON BOLTS	4
	H3		HEX HEAD CROSS BOLT 3/8" X 2-3/8" (M10X60mm)	8
	H4		FLAT WASHER 3/8" I.D.	8
WOOD	P1		CUSHION	1
	P2		TABLE TOP	1
	P3		APRON	1
	P4		LEG BEAM	1
	P5		LEG	4
	P6		PEDESTAL	1
	P7		WOOD JOINT	8

HAMILTON POKER TABLE



Presidential Billiards, L.P.

Step 1

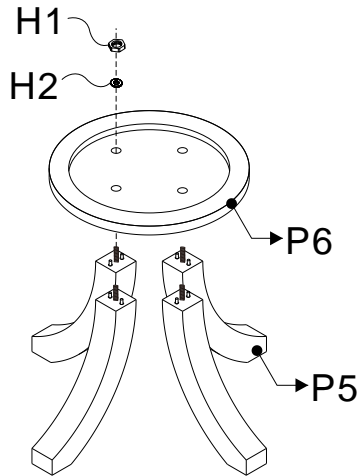

Step 2

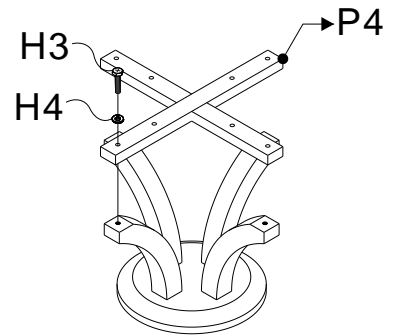

Step 3

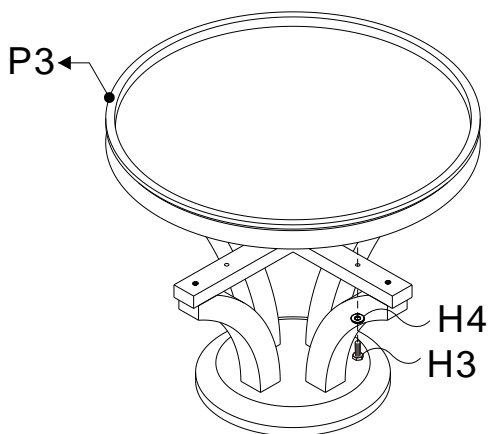

Finish

